



ML401

1.7–2.2 GHz High IP3 Mixer with Integrated LO Amp

The Communications Edge™

Product Information

Product Features

- High dynamic range mixer with integrated LO driver
- +31 dBm Input IP3
- 8 dB Conversion Loss
- RF: 1700 – 2200 MHz
- LO: 1550 – 2150 MHz
- IF: 50 – 250 MHz
- 0 dBm Drive Level
- RoHS-compliant SOIC-8 pkg

Applications

- 2.5/3G GSM/CDMA/WCDMA
- DCS/PCS-band Mobile Infrastructure

Product Description

The ML401 high linearity upconverter or downconverter combines a passive GaAs MESFET mixer with an integrated HBT LO driver in a low-cost lead-free/green/RoHS-compliant SOIC-8 package. WJ's ML401 uses patented techniques to realize +31 dBm Input IP3 with 8 dB conversion loss using an LO drive level of 0 dBm in a downconverting application. The on-chip diplexer in the mixers allows for good matching on the RF and IF ports. The dual-stage LO driver provides a stable input power level into the mixer to allow for consistent performance over a wide range of LO power levels.

Typical applications include frequency up/down conversion, modulation and demodulation for receivers and transmitters used in 2.5G and 3G GSM/CDMA/W-CDMA systems in the DCS, PCS, or UMTS frequency bands.

Functional Diagram

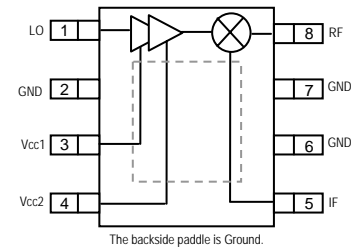

Specifications ⁽¹⁾

Parameter	Units	Min	Typ	Max	Min	Typ	Max	Min	Typ	Max
RF Frequency Range	MHz		1700 – 1800			1800 – 2000			2000 – 2200	
LO Frequency Range	MHz		1550 – 1750			1600 – 1950			1750 – 2150	
IF Frequency Range	MHz		50 – 150			50 – 250			50 – 250	
SSB Conversion Loss	dB		8.2			8.2	9		8.2	
Input IP3 ⁽²⁾	dBm		+31		+28	+30			+30	
Input P1dB	dBm		+17			+19			+20	
LO – RF Isolation ⁽³⁾	dB		9			8			8	
LO – IF Isolation ⁽³⁾	dB		27			27			27	
RF – IF Isolation	dB		19			20			21	
Return Loss: RF Port	dB		16			16			16	
Return Loss: IF Port	dB		25			25			25	
Return Loss: LO Port	dB		15			15			15	
LO Drive Level	dBm	-2.5	0	2.5	-2.5	0	2.5	-2.5	0	2.5
Operating Supply Voltage	V		+5			+5			+5	
Operating Current ⁽⁴⁾	mA		102		85	105	135		110	

1. Min / max limits are tested for the mixer in downconverting application with a low-side LO at 0 dBm at 25 °C with RF/IF = 1800/50, 2000/50, and 1800/200 MHz.
 2. IP3 is measured with Δf = 1 MHz with RF_{in} = 0 dBm / tone.
 3. LO is injected with 0 dBm.
 4. This refers to the operating current under LO drive. The current can be reduced by increasing the value of the R2 resistor slightly.

Absolute Maximum Rating

Parameter	Rating
Operating Case Temperature	-40 to +85 °C
Storage Temperature	-55 to +150 °C
DC Voltage	+5.5 V
LO Power	+10 dBm
Input IF / RF Power	+20 dBm

Operation of this device above any of these parameters may cause permanent damage.

Ordering Information

Part No.	Description
ML401-G	1.7–2.2 GHz High IP3 Mixer w/ Integrated LO Amp (lead-free/green/RoHS-compliant SOIC-8 package)
ML401-PCB	Full Assembled Evaluation Board

Specifications and information are subject to change without notice



ML401

1.7-2.2 GHz High IP3 Mixer with Integrated LO Amp

The Communications Edge™

Product Information

Typical Downconversion Performance Plots Performance using the circuitry on the ML401-PCB Evaluation Board

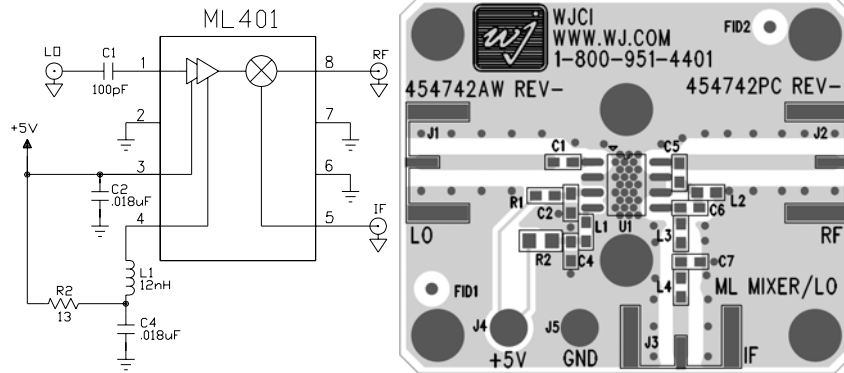

R1 is shown in the silkscreen but is not required for the ML401. A 0Ω jumper is placed in this spot on the PCB.

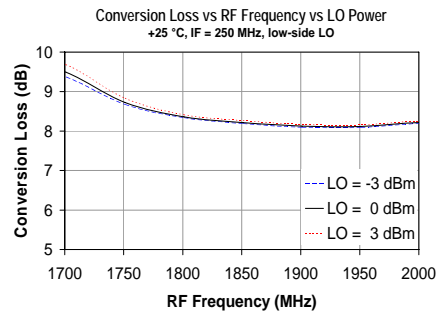
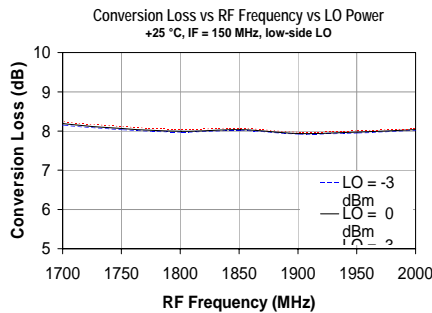
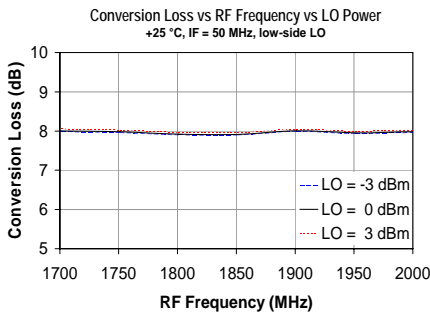
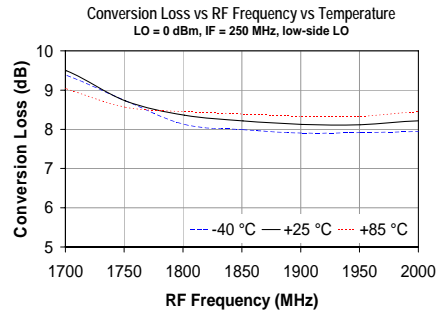
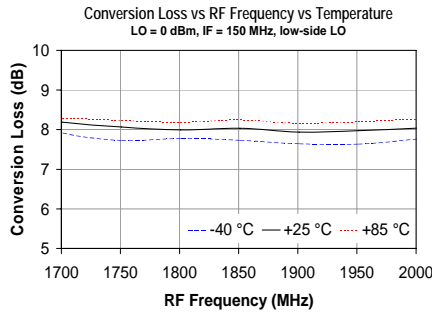
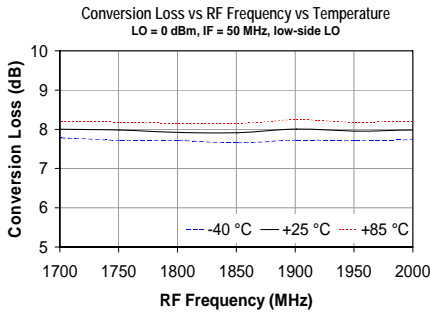
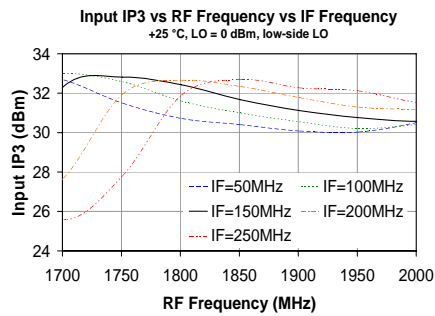
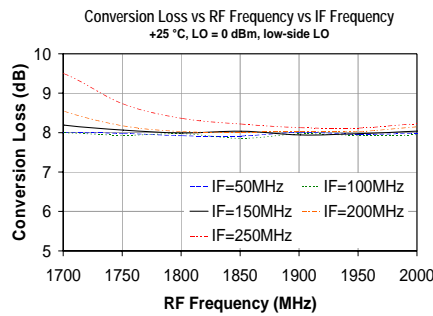

Specifications and information are subject to change without notice



Typical Downconversion Performance Plots (cont'd) Performance using the circuitry on the ML401-PCB Evaluation Board

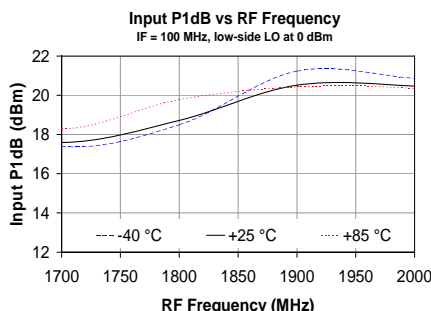
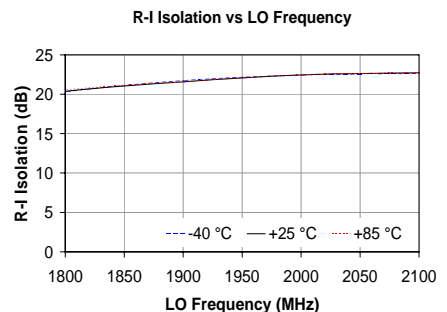
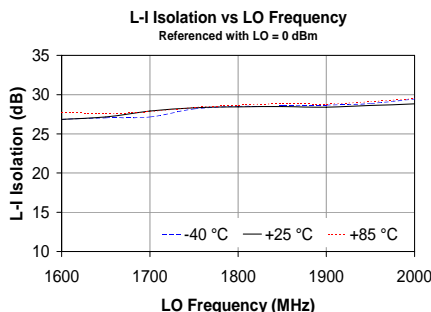
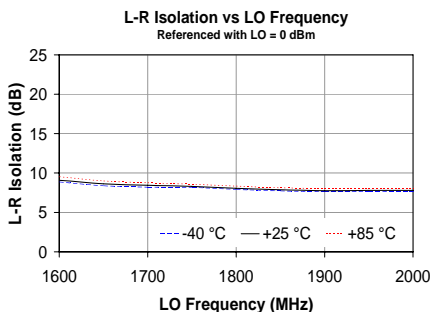
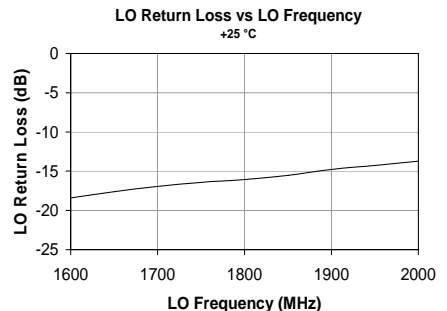
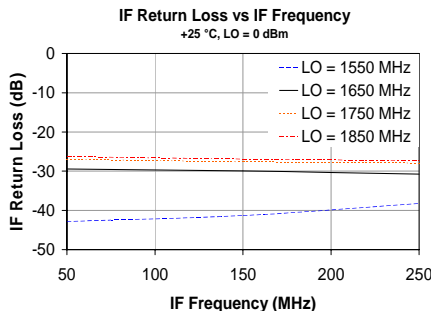
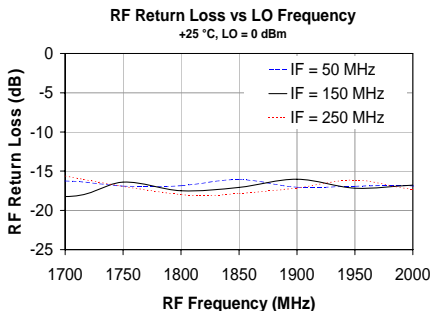
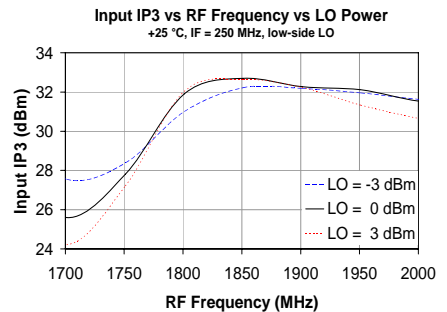
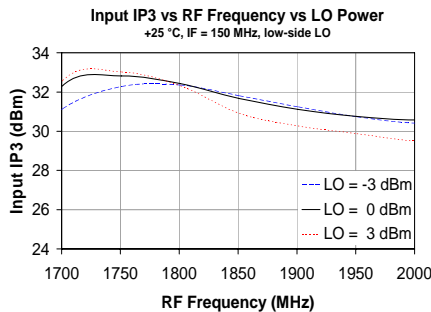
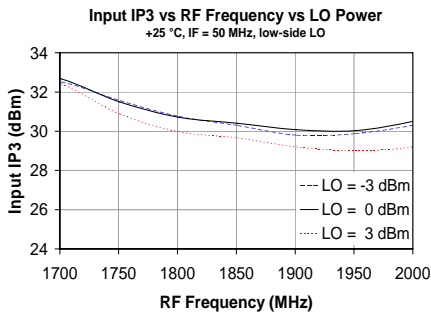
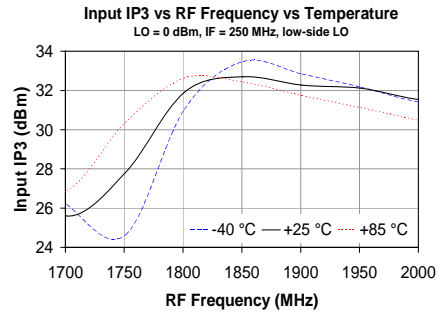
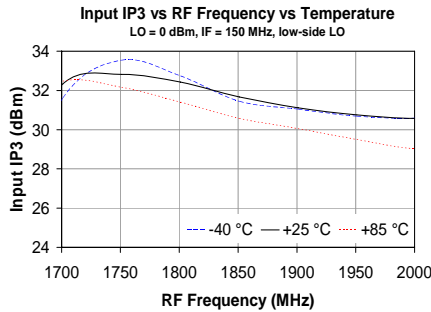
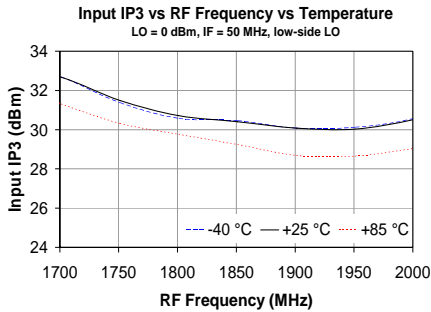



ML401

1.7-2.2 GHz High IP3 Mixer with Integrated LO Amp

The Communications Edge™

Product Information

ML401-G Mechanical Information

This package is lead-free/green/RoHS-compliant. The plating material on the leads is NiPdAu. It is compatible with both lead-free (maximum 260 °C reflow temperature) and lead (maximum 245 °C reflow temperature) soldering processes.

Outline Drawing

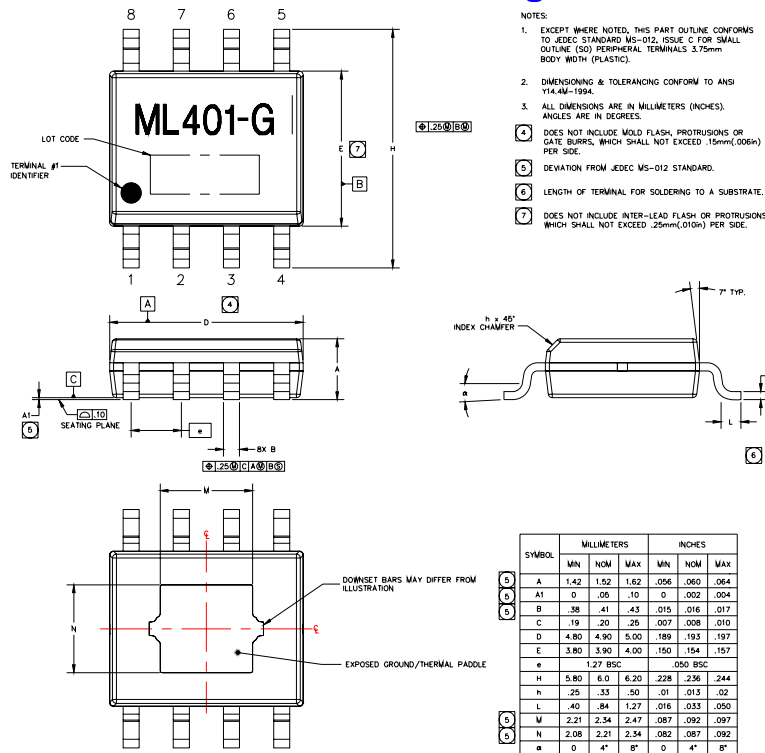

Product Marking

The component will be lasermarked with a "ML401-G" product label with an alphanumeric lot code on the top surface of the package.

Tape and reel specifications for this part will be located on the website in the "Application Notes" section.

ESD / MSL Information



Caution! ESD sensitive device.

ESD Rating: Class 1B
 Value: Passes ≥ 500V to <1000V
 Test: Human Body Model (HBM)
 Standard: JEDEC Standard JESD22-A114

ESD Rating: Class IV
 Value: Passes ≥ 1000V
 Test: Charged Device Model (CDM)
 Standard: JEDEC Standard JESD22-C101

MSL Rating: Level 2 at +260 °C convection reflow
 Standard: JEDEC Standard J-STD-020

Mounting Configuration / Land Pattern

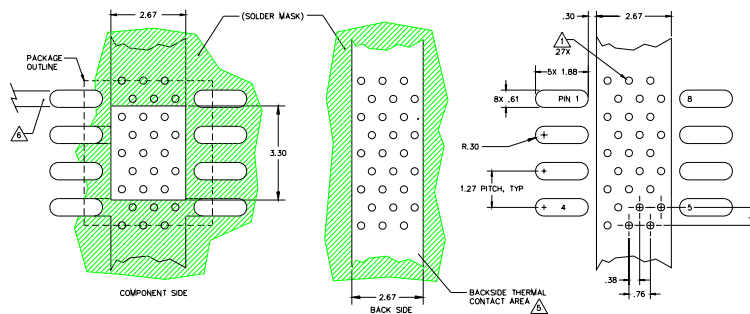

- Ground / thermal vias are critical for the proper performance of this device. Vias should use a .35mm (#80 / .0135") diameter drill and have a final plated thru diameter of .25 mm (.010").
- Add as much copper as possible to inner and outer layers near the part to ensure optimal thermal performance.
- Mounting screws can be added near the part to fasten the board to a heatsink. Ensure that the ground / thermal via region contacts the heatsink.
- All dimensions are in millimeters (inches). Angles are in degrees.
- Do not put solder mask on the backside of the PC board in the region where the board contacts the heatsink.
- RF trace width depends upon the PC board material and construction.
- Use 1 oz. Copper minimum.

Functional Pin Layout

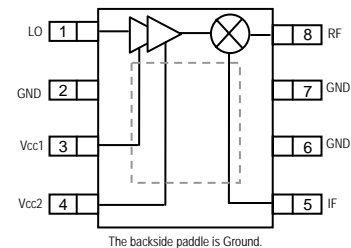

Pin	Function
1	LO
2	GND
3	Vcc1
4	Vcc2
5	IF
6	GND
7	GND
8	RF

Backside paddle is RF and DC ground.

Thermal Specifications

Parameter	Rating
Operating Case Temperature	-40 to +85 °C
Thermal Resistance, Rth	104 °C / W

Specifications and information are subject to change without notice